

# NORM-GAS

VALVOLE A SFERA

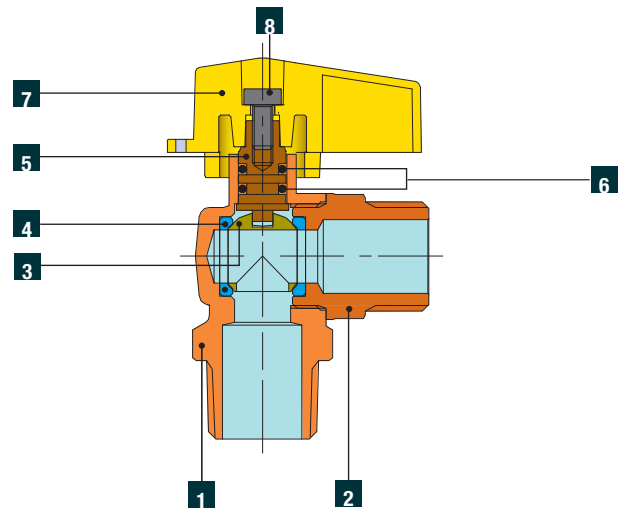

Denominazione	Pz.	Materiale
<b>1</b> Corpo	1	UNI EN 12165 CW617N
<b>2</b> Manicotto	1	UNI EN 12165 CW617N
<b>3</b> Sfera	1	UNI EN 12165 CW617N UNI EN 12164 CW617N
<b>4</b> Sedi tenuta sfera	2	P.T.F.E. vergine
<b>5</b> Asta	1	UNI EN 12164 CW617N
<b>6</b> O-Ring tenuta asta	2	NBR 70 Sh A (ASTM D 2240)
<b>7</b> Leva	1	Alluminio verniciato
<b>8</b> Vite	1	Acciaio zincato

## IT CARATTERISTICHE GENERALI

Passaggio: Standard  
 Gamma: Da 1/2"  
 Filettatura corpo: UNI EN 10226-1 (UNI EN ISO 7/1 Rp e R) (DIN2999)  
 Filettatura manicotto Maschio: UNI EN ISO 228-1 (DIN 259);  
 Filettatura manicotto Femmina: UNI EN 10226-1 (UNI EN ISO 7/1 Rp) (DIN2999)  
 Manovra: Rotazione di 90° dell'organo di manovra.  
 Organi di manovra: Levetta in alluminio verniciata, sigillabile in chiusura.

## CONDIZIONI DI ESERCIZIO

Direzione del Flusso: per i rubinetti a squadra dal basso verso la via laterale.  
 Temperatura di esercizio: da -20 °C a +60 °C  
 Pressione di esercizio: MOP 5  
 Le valvole devono essere utilizzate in posizione completamente aperta o chiusa.  
 Portagomma a norma UNI 7141/91 per il collegamento di tubi flessibili non metallici a norme UNI 7140/93.

Le presenti valvole sono idonee per l'utilizzo con gas delle tre famiglie (metano, gas di città, GPL), per reti e impianti di distribuzione a bassa e media pressione; per utilizzi particolari (nel rispetto delle pressioni stabilite per queste valvole) vedere tabella compatibilità chimiche negli allegati tecnici del catalogo vigente. Articoli compresi nella marcatura CE, come da Art. 4 Paragrafo 3 della Direttiva 2014/68/UE.

GP 2140  
NORM-GAS

Rubinetto a sfera diretto Femmina-Femmina ISO 7, con levetta alluminio gialla.

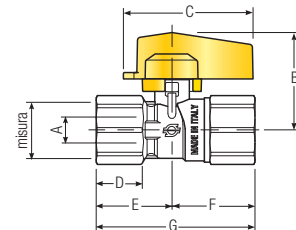
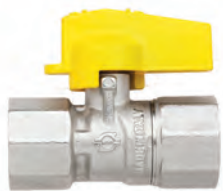

CODICE	Misura	A mm	B mm	C mm	D mm	E mm	F mm	G mm	gr	Conf. pz/sc	Master pz/sc
8100R104	1/2"	10	37,6	48	17	28	30,75	58,75	141	20	160

GP 2140  
NORM-GAS

Rubinetto a sfera diretto Maschio-Femmina ISO 7, con levetta alluminio gialla.

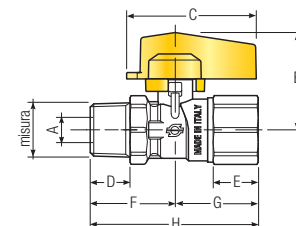

CODICE	Misura	A mm	B mm	C mm	D mm	E mm	F mm	G mm	H mm	gr	Conf. pz/sc	Master pz/sc
8101R104	1/2"	10	37,6	48	14,8	17	31,75	30,75	62,5	143	20	160

GP 2140  
NORM-GAS

Rubinetto a sfera diretto Maschio ISO 7-Maschio ISO 228, con levetta alluminio gialla.

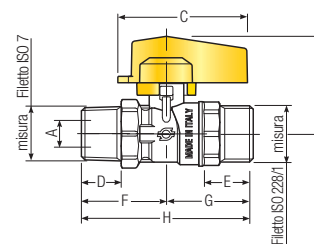

CODICE	Misura	A mm	B mm	C mm	D mm	E mm	F mm	G mm	H mm	gr	Conf. pz/sc	Master pz/sc
8103R076	1/2"	10	37,6	48	14,8	17	31,75	30,75	62,5	143	20	160

GP 2140  
NORM-GAS

Rubinetto a sfera diretto Femmina ISO 7-Portagomma GAS UNI 7141, con levetta alluminio gialla.

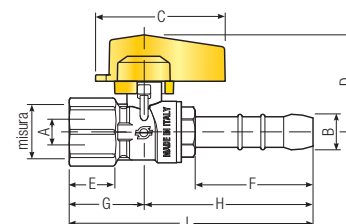
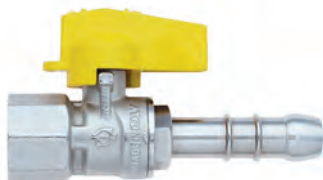

CODICE	Misura	A mm	B mm	C mm	D mm	E mm	F mm	G mm	H mm	I mm	gr	Conf. pz/sc	Master pz/sc
8104R104	1/2"	10	14	48	37,6	17	44	28	63	91	145	20	160

GP 2140  
NORM-GAS

Rubinetto a sfera diritto Maschio ISO 7-Portagomma GAS UNI 7141,  
con levetta alluminio gialla.

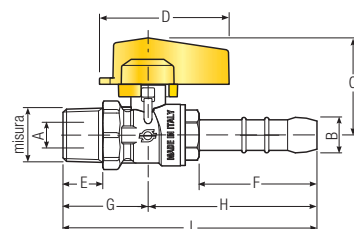

CODICE	Misura	øA mm	øB mm	C mm	D mm	E mm	F mm	G mm	H mm	I mm	gr	Conf. pz/sc	Master pz/sc
8105R104	1/2"	10	14	37,6	48	14,8	44	31,75	63	94,75	148	20	160



[UNI EN 331]

GP 2140  
NORM-GAS

Rubinetto a sfera diritto Femmina ISO 7-Portagomma GPL UNI 7141,  
con levetta alluminio gialla.

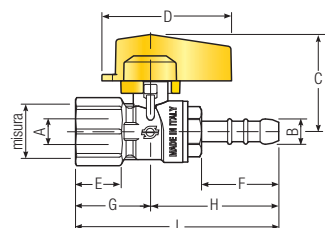
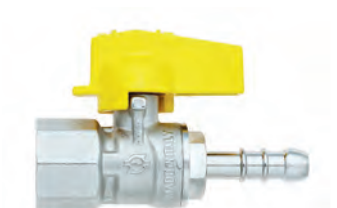

CODICE	Misura	A mm	B mm	C mm	D mm	E mm	F mm	G mm	H mm	I mm	gr	Conf. pz/sc	Master pz/sc
8106R104	1/2"	10	9,8	37,6	48	17	29	28	48	76	131	20	160



[UNI EN 331]

GP 2140  
NORM-GAS

Rubinetto a sfera diritto Maschio ISO 7-Portagomma GPL UNI 7141,  
con levetta alluminio gialla.

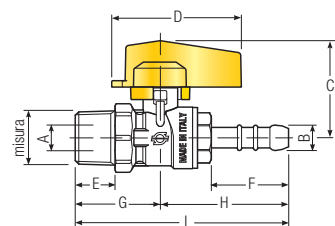

CODICE	Misura	A mm	B mm	C mm	D mm	E mm	F mm	G mm	H mm	I mm	gr	PN	Conf. pz/sc	Master pz/sc
8107R104	1/2"	10	9,8	37,6	48	14,8	29	31,75	48	79,75	136	4	20	160



[UNI EN 331]

GP 2140  
NORM-GAS

Rubinetto a sfera diritto Femmina ISO 7-Dado girevole Femmina ISO 228,  
con levetta alluminio gialla.

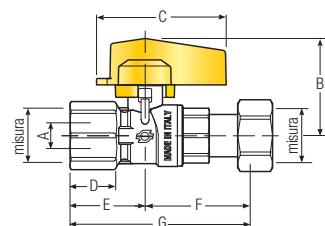

CODICE	Misura	A mm	B mm	C mm	D mm	E mm	F mm	G mm	gr	Conf. pz/sc	Master pz/sc
8108R076	1/2"Fx1/2"D	10	37,6	48	17	28	39	67	167	20	160
8108R077	1/2"Fx3/4"D	10	37,6	48	17	28	39	67	171	20	160



[UNI EN 331]



GP 2140  
NORM-GAS

Rubinetto a sfera diritto Maschio ISO 7-Dado girevole Femmina ISO 228,  
con levetta alluminio gialla.

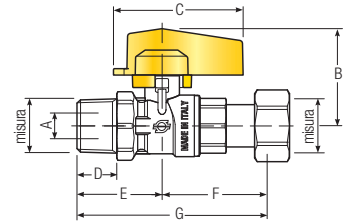

CODICE	Misura	A mm	B mm	C mm	D mm	E mm	F mm	G mm	gr	Conf. pz/sc	Master pz/sc
8109R076	1/2" M x 1/2" D	10	37,6	48	14,8	31,75	39	70,75	171	20	160
8109R077	1/2" M x 3/4" D	10	37,6	48	14,8	31,75	39	70,75	175	20	160

GP 2140  
NORM-GAS

Rubinetto a sfera a squadra Femmina-Femmina ISO 7,  
con levetta alluminio gialla.

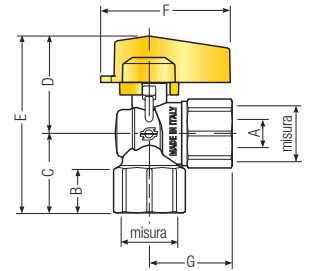

CODICE	Misura	A mm	B mm	C mm	D mm	E mm	F mm	G mm	gr	Conf. pz/sc	Master pz/sc
8110R104	1/2" x 1/2"	10	17	31	37,6	68,6	48	30,75	147	20	160

GP 2140  
NORM-GAS

Rubinetto a sfera a squadra Maschio-Femmina ISO 7,  
con levetta alluminio gialla.

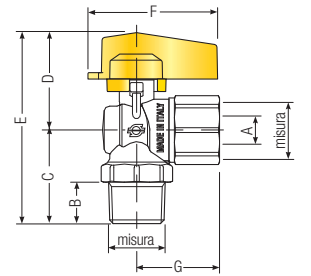

CODICE	Misura	A mm	B mm	C mm	D mm	E mm	F mm	G mm	gr	Conf. pz/sc	Master pz/sc
8111R104	1/2" x 1/2"	10	14,8	34,5	37,6	72,1	48	30,75	152	20	160

GP 2140  
NORM-GAS

Rubinetto a sfera a squadra Femmina ISO 7-Maschio ISO 228,  
con levetta alluminio gialla.

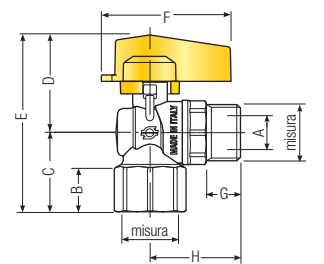

CODICE	Misura	A mm	B mm	C mm	D mm	E mm	F mm	G mm	H mm	gr	Conf. pz/sc	Master pz/sc
8112R076	1/2" x 1/2"	10	17	31	37,6	68,6	48	12	31,5	145	20	160

GP 2140  
NORM-GAS



Rubinetto a sfera a squadra Maschio ISO 7-Maschio ISO 228, con levetta alluminio gialla.

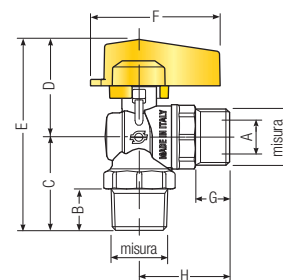

CODICE	Misura	A mm	B mm	C mm	D mm	E mm	F mm	G mm	H mm	gr	Conf. pz/sc	Master pz/sc
8113R076	1/2"x1/2"	10	14,8	34,5	37,6	72,1	48	12	31,5	149	20	160



GP 2140  
NORM-GAS



Rubinetto a sfera a squadra Femmina ISO 7-Portagomma GAS UNI 7141, con levetta gialla.

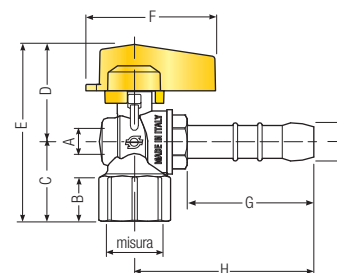

CODICE	Misura	A mm	B mm	C mm	D mm	E mm	F mm	G mm	H mm	øI mm	gr	Conf. pz/sc	Master pz/sc
8114R104	1/2"	10	17	31	37,6	68,6	48	44	63	14	152	20	160



GP 2140  
NORM-GAS



Rubinetto a sfera a squadra Maschio ISO 7-Portagomma GAS UNI 7141, con levetta gialla.

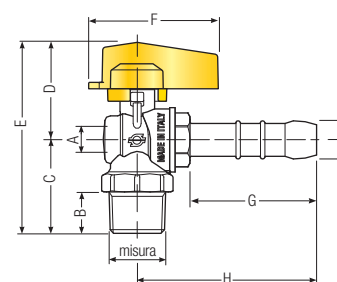

CODICE	Misura	A mm	B mm	C mm	D mm	E mm	F mm	G mm	H mm	I mm	gr	Conf. pz/sc	Master pz/sc
8115R104	1/2"	10	14,8	31	37,6	68,6	48	44	63	14	157	20	160



GP 2140  
NORM-GAS



Rubinetto a sfera a squadra Femmina ISO 7-Portagomma GPL UNI 7141, con levetta gialla.

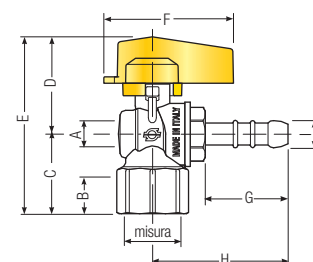

CODICE	Misura	A mm	B mm	C mm	D mm	E mm	F mm	G mm	H mm	I mm	gr	Conf. pz/sc	Master pz/sc
8116R104	1/2"	10	17	31	37,6	68,6	48	29	48	9,8	139	20	160



GP 2140  
NORM-GAS

Rubinetto a sfera a squadra Maschio ISO 7-Portagomma GPL UNI 7141,  
con levetta alluminio gialla.

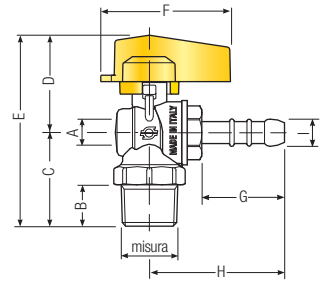

[UNI EN 331]

CODICE	Misura	A mm	B mm	C mm	D mm	E mm	F mm	G mm	H mm	I mm	gr	Conf. pz/sc	Master pz/sc
<b>8117R104</b>	1/2"	10	15	35	37.6	72.1	48	29	48	9.8	142	20	160

GP 2140  
NORM-GAS

Rubinetto a sfera a squadra Femmina ISO 7-Dado girevole Femmina ISO 228,  
con levetta alluminio gialla.

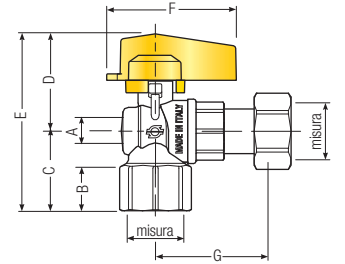

[UNI EN 331]



CODICE	Misura	A mm	B mm	C mm	D mm	E mm	F mm	G mm	gr	Conf. pz/sc	Master pz/sc
<b>8118R076</b>	1/2"Fx1/2"D	10	17	31	37.6	68.6	48	39	174	20	160
<b>8118R077</b>	1/2"Fx3/4"D	10	17	31	37.6	68.6	48	39	178	20	160

GP 2140  
NORM-GAS

Rubinetto a sfera squadra Maschio ISO 7-Dado girevole Femmina ISO 228,  
con levetta alluminio gialla.

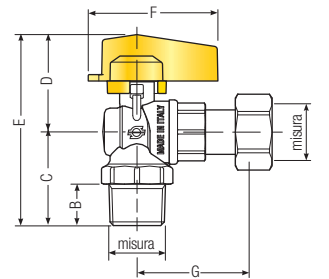

[UNI EN 331]



CODICE	Misura	A mm	B mm	C mm	D mm	E mm	F mm	G mm	gr	Conf. pz/sc	Master pz/sc
<b>8119R076</b>	1/2"Mx1/2"D	10	14.8	34.5	37.6	72.1	48	39	177	20	160
<b>8119R077</b>	1/2"Mx3/4"D	10	14.8	34.5	37.6	72.1	48	39	181	20	160